

***TROY***®  
**BARBELL & FITNESS**



# ***TABLE OF CONTENTS***

## ***TITLE PAGES***

## ***PAGE NUMBERS***

Logos	Page 1-3
New Products Coming Soon	Page 4-5
New Products Available Now	Page 6
Dumbbells & Storage	Page 7-11
Barbells & Storage	Page 12-14
Bars & Plates	Page 15-25
-Bumper Plates	Page 15-19
-Grip Plates	Page 21-23
-Bars	Page 15,20,24-25
Racks & Benches	Page 26-30
Kettlebell & Storage	Page 31-34
Accessories	Page 35-38
Warranties	Page 39-40

***LASER ENGRAVING***



***SCREEN PRINTING***



***CUSTOM COLOR***



**CUSTOM LOGO OPTIONS AVAILABLE**

**TSD-UL**  
12-Sided Urethane  
Dumbbell



**TSD-UTL**  
Troy Round Urethane  
Dumbbell



**XD-UL**  
VTX Round Urethane  
Dumbbells



**GO-VUL**  
Urethane Grip Plates



**BPO-SBPL**  
Black Bumper Plates



**GO-UL**  
Urethane Interlocking Plates



**BPO-SBP2L**  
Black Bumper Plates  
(Dual Logo)



**BCO-SBPL**  
Logo Competition Bumper



**TSB-UL**  
Urethane Straight  
Barbell



**TZB-UL**  
Urethane EZ  
Barbell



**XSB-UL**  
VTX Urethane  
Straight Barbell



**XZB-UL**  
VTX Urethane EZ  
Barbell



**AOB-1500CL/AOB-1200CL**  
Men and Women's Cerakote Bar

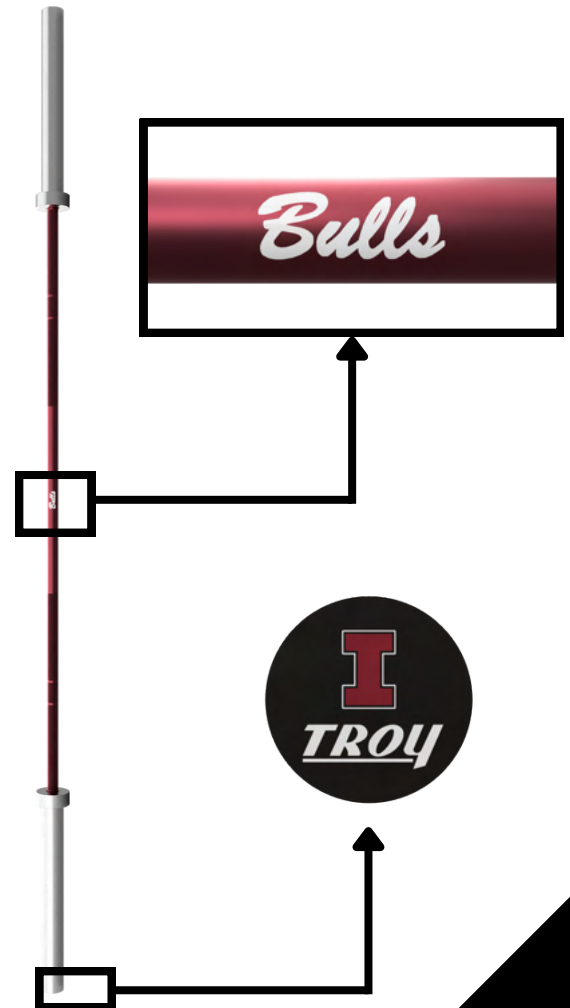

**NEW CUSTOM COLOR OPTIONS AVAILABLE**

AOB-1500CL/

AOB1200CL

GO-UL

PO-SBPL

TSD-UL

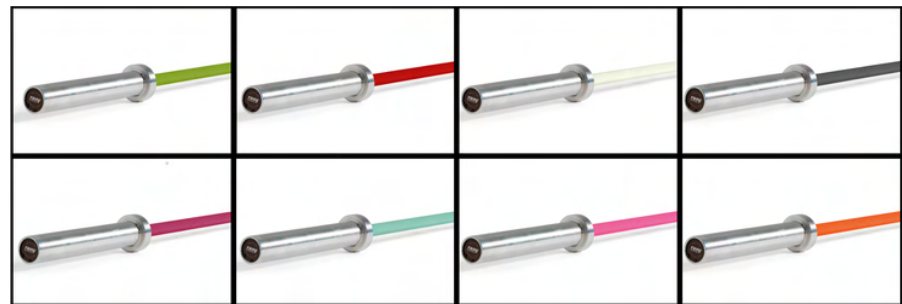

\*Custom Logos available with custom color options as well

\*TSD-UL, PO-SBPL, & GO-UL are available in pantone color

\*Custom Color options for cerakote bars include any of the H-Series Cerakote Coatings

# NEW PRODUCTS COMING SOON

Pro Force Infinite 3000  
Modular Storage Racks



Pro Force Infinite 1000  
Modular Storage Racks

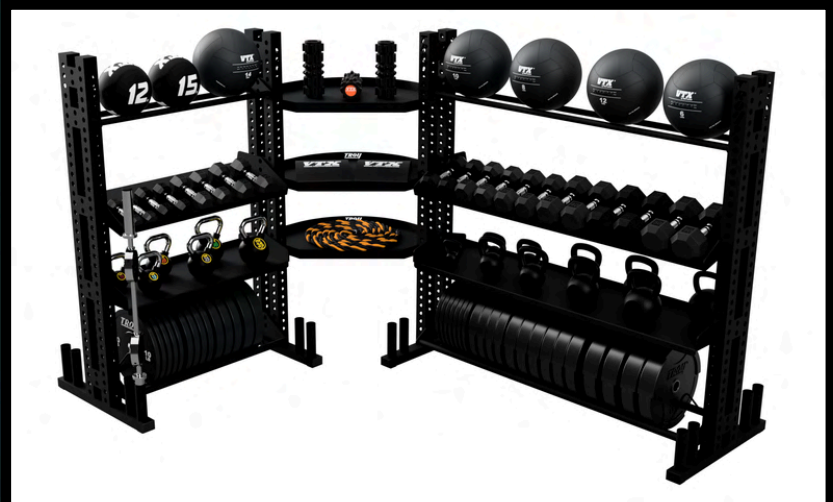

Pro Force Infinite 2000  
Modular Storage Racks



Pro Force Platform



# NEW PRODUCTS COMING SOON

Pro Force Series 1  
Power Rack Small



Pro Force Series 1  
Power Rack Large



DAP-FT

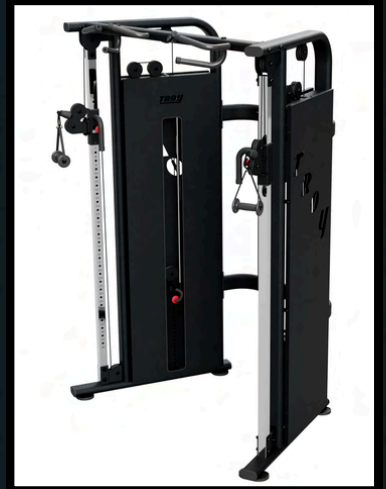

Pro Force Sled Runner and Wheels





# NEW PRODUCTS AVAILABLE NOW

## VTX PERFORMANCE BARS



**GOB-1500BC & GOB-1500HC**

## VTX URETHANE STRAIGHT BARBELL



**XSB-U**

CUSTOM LOGO OPTIONS AVAILABLE

## VTX URETHANE EZ BARBELL



**XZB-U**

CUSTOM LOGO OPTIONS AVAILABLE

# DUMBBELLS & STORAGE

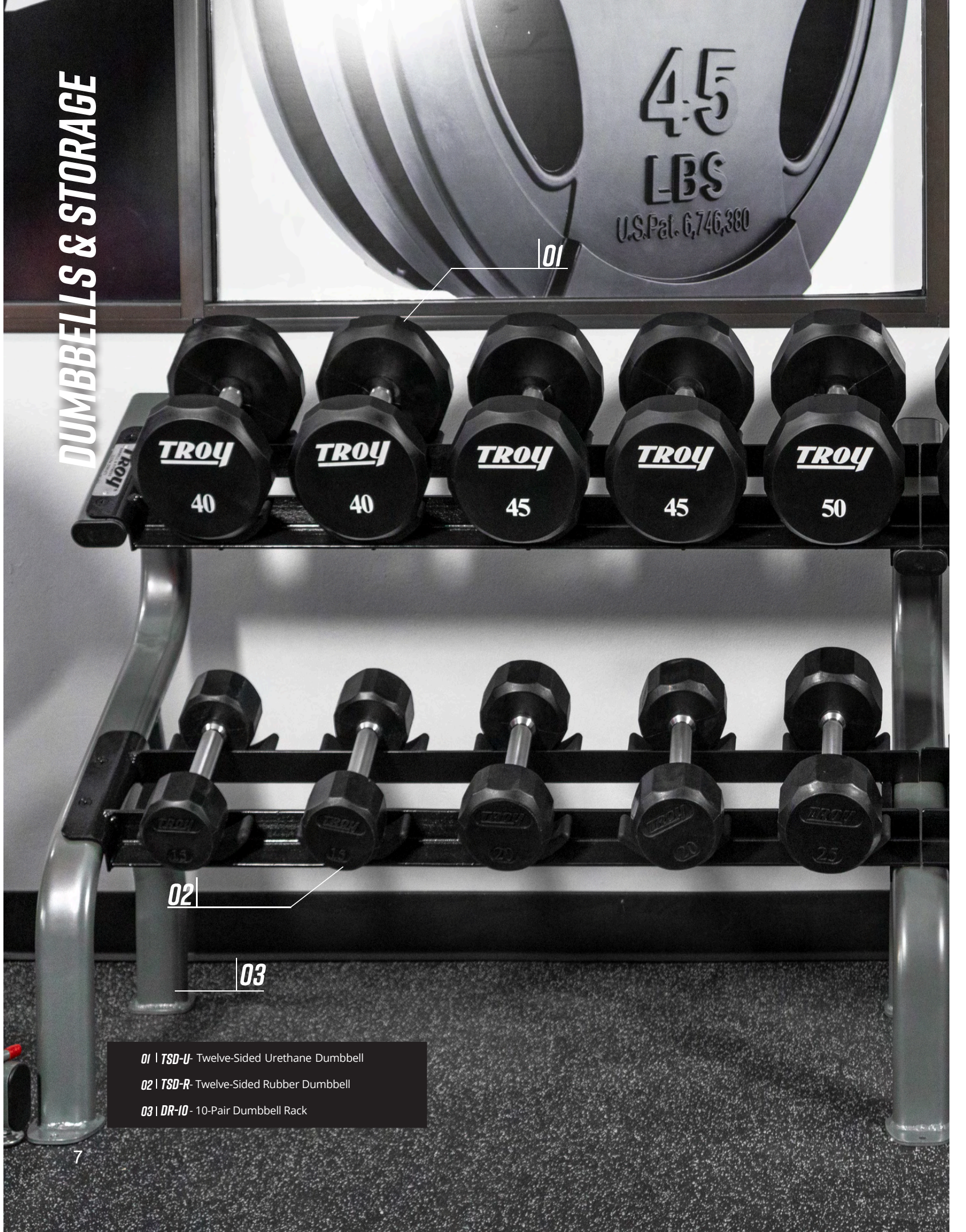

01

02

03

- 01 | *TSD-U* - Twelve-Sided Urethane Dumbbell
- 02 | *TSD-R* - Twelve-Sided Rubber Dumbbell
- 03 | *DR-10* - 10-Pair Dumbbell Rack

**01 | TSD-U - TWELVE-SIDED URETHANE DUMBBELL**

The TSD-U has a sleeve design that extends through the head of the dumbbell and is permanently welded, the structural integrity is unsurpassed.

- 2% weight tolerance
- Largest size: 125 lbs.
- For use with DR-15, DR-10, GTDR-3, and T-DR racks

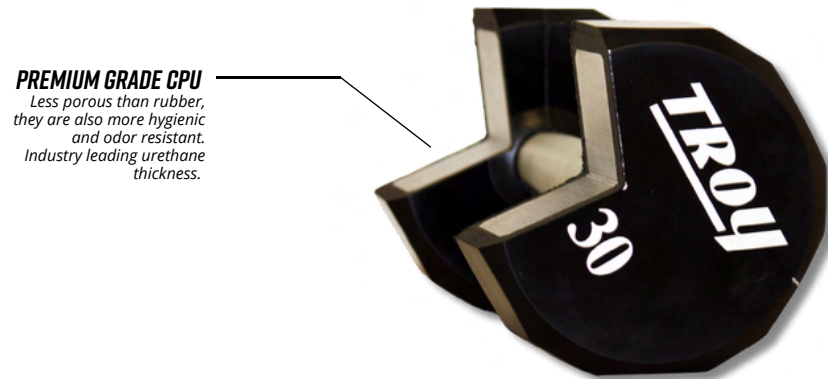

## 02 | TSD-R - TWELVE-SIDED RUBBER DUMBBELL

Precision machined, graduated steel handles are coated with a hard chrome finish to resist corrosion. Perfect for any workout setting-from the best health club to the home.

- 2% weight tolerance
- Largest size: 125 lbs.
- For use with DR-15, DR-10, GTDR-3, GVDR-13 (to 50lbs), GVDR-8 (to 25lbs) and T-DR racks

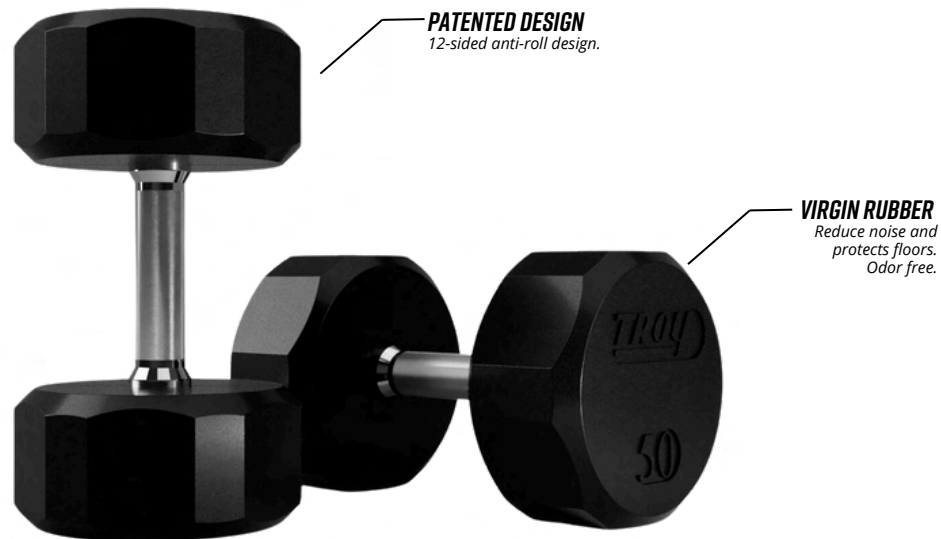

## 03 | DR-10/DR-10-MBLK - 10-PAIR DUMBBELL RACK

- Scratch-resistant, powder-coated finish
- Durable plastic saddles help protect dumbbells and reduce noise.
- Available in silver or matte black



**04 | DR-15 /DR-15-MBLK- TROY 15 - PAIR DUMBBELL RACK**

- 3.5mm thick steel tubes
- Weight capacity of 3,450lbs
- With scratch-resistant, powder-coated finish
- Durable plastic saddles help protect dumbbells and reduce noise
- Available in silver or matte black



**05 | TDR-3 - VTX HORIZONTAL DUMBBELL RACK**

- Holds up to 23 pairs
- Constructed with 12-gauge heavy duty 2" x 2" tubing



**06 | GTDR-3 - VTX 3-TIER DUMBBELL SHELF RACK**

- Holds a 5-75 run of solid dumbbells (15 pairs)
- Powder-coated shelves
- 11-gauge steel frame for quick, easy assembly.



## 07 | XD-U - VTX URETHANE DUMBBELL

- High grade TPU
- Round Head Design
- Proprietary bolt to head construction w/ finished endcap
- Available for screen printing client logo
- Largest size: 125 lbs
- For use with DR-15 and DR-10 racks



## 08 | SD-U - URETHANE HEX DUMBBELL

- Premium grade CPU
- 8-sided anti-roll design
- Welded head to handle construction
- 28 & 34 mm chrome contoured handles
- Largest size: 125 lbs
- For use with DR-15, DR-10, GTDR-3, GVDR-13 (to 50lbs), GVDR-8 (to 25lbs) and T-DR racks



## 09 | SD-R - RUBBER HEX DUMBBELL

- Premium grade rubber
- 8-sided anti-roll design
- Welded head to handle construction
- 28 & 34 mm chrome contoured handles
- Largest size: 100 lbs
- For use with DR-15, DR-10, GTDR-3, GVDR-13 (to 50lbs), GVDR-8 (to 25lbs) and T-DR racks



# BARBELLS & STORAGE



## **10 BB-5 - BARBELL HALF RACK**

The Troy Fitness Half Barbell rack is constructed using sturdy steel tubing with a wide stable base. Designed to be a compact storage solution, the rack keeps 5 Fixed Weight Barbells organized and safely stored within a small footprint. Urethane hooks extend along the front of the rack to minimize the impact on the bar knurling to protect equipment and add durability

**11 | TSB-U/TSB-R - 12 SIDED STRAIGHT BARBELL**

Our patented 12-sided Straight Barbell features a solid steel head encased in Urethane and Rubber that is securely attached to a hard chrome, steel bar.

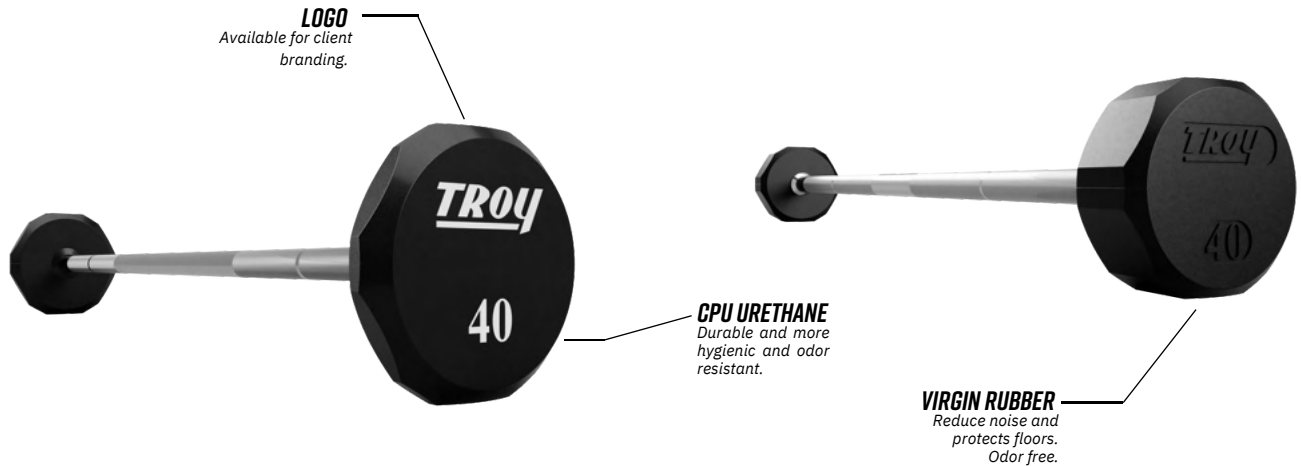

**12 | TZB-U/TZB-R - 12 SIDED EZ CURL BARBELL**

Our patented 12-sided EZ Curl Barbell features a solid steel head encased in Urethane and Rubber that is securely attached to a hard chrome, steel bar.





**13 BB-10/BB-10-MBLK - HORIZONTAL BARBELL RACK**

Our redesigned Horizontal Barbell Rack is dual sided and can hold 10 fixed barbells or fixed curl bars. The chrome wear-guard adds to the striking look of this barbell rack.



# BARS & PLATES



- 14 AOB-1500T - Blackwing Bar
- 15 BPO-SBP - Black Premium Rubber Bumper Plate

## 14 AOB-1500T - BLACKWING BAR

The new Troy Blackwing bar is 100% manufactured in the USA. With a U.S. lab tested yield strength of 213,300 P.S.I., this bar is in a class by itself - so impressive, we put the Troy badge on it as the established benchmark for American made training/power bars. It can be put into any application without worry, and is virtually maintenance free. Perfect for use in a professional, college or high school weight room setting.



## 15 BPO-SBP - BLACK PREMIUM RUBBER BUMPER PLATE

The Troy Black Premium Rubber Bumper Plates provide the perfect mix of performance with low bounce to protect gym flooring. Molded from the highest-grade rubber over a solid cast iron core and precision-milled steel hubs. Designed with raised weight numbers for easy identification. These plates are available in four colors for each weight.



**LOGO**  
Available for client branding.



**BUMPER PLATES**

***16 | PO-SBP - COLOR PREMIUM RUBBER BUMPER PLATE***

The Color Premium Rubber Bumper Plate provides the perfect mix of performance with low bounce to protect gym flooring. Molded from the highest-grade virgin rubber over a solid cast iron core and precision-milled steel hubs. Designed with raised weight numbers for easy identification. These plates are available in four colors for each weight.

# CRUMB RUBBER BUMPER PLATES

## 17 | GO-CBP - USA CRUMB RUBBER BUMPER PLATES

The USA Crumb Bumper Plate is designed for both aesthetic and function. You'll find the look fits the rugged functional training market while the design holds up to the highest volume of usage. The recycled rubber design allows for impact to be distributed well across the plate and promotes durability and longevity.

Plate Diameter: 17.716in (450mm)

Plate Width: 10 lbs. (Green) - 1.377in (35mm)

15 lbs. (Gray) - 1.653in (42mm)

25 lbs. (Yellow) - 2.362in (60mm)

35 lbs. (Blue) - 2.834in (72mm)

45 lbs. (Red) - 3.267in (83mm)



**18 | BCO-SBP - BLACK COMPETITION BUMPER PLATE**

- Withstand 30,000 drops
- Solid steel core
- 50.3mm center hole provides a snug fit on the bar
- 2 year warranty
- Available in pounds: 25lbs, 35lbs, 45lbs & 55lbs.
- Accurate to within a 1% (+ or -) weight tolerance.
- Available for custom logo

ITEM	WIDTH
BCO-025SBP	32.5mm
BCO-035SBP	43mm
BCO-045SBP	54.5mm
BCO-055SBP	66.5mm



**19 | CCO-SBP - COLOR COMPETITION BUMPER PLATE**

- Withstand 30,000 drops
- Solid steel core
- 50.3mm center hole provides a snug fit on the bar
- 2 year warranty
- Available in pounds: 25lbs, 35lbs, 45lbs & 55lbs.
- Accurate to within a 1% (+ or -) weight tolerance.

ITEM	WIDTH
CCO-025SBP	32.5mm
CCO-035SBP	43mm
CCO-045SBP	54.5mm
CCO-055SBP	66.5mm



**20 | CO-SBP - COLOR COMPETITION BUMPER PLATE - KGS**

- Withstand 30,000 drops
- Solid steel core
- 50.3mm center hole provides a snug fit on the bar
- 2 year warranty
- Available in pounds: 10kgs, 15kgs, 20kgs, 25kgs
- Accurate to within a 1% (+ or -) weight tolerance.

ITEM	WIDTH
CO-010SBP	34mm
CO-015SBP	47mm
CO-020SBP	60mm
CO-025SBP	73mm



**21 | BO-SBP - SOLID RUBBER INTERLOCKING BUMPER PLATE**

- Patented Interlocking design
- Premium Rubber

ITEM	WIDTH
BO-010SBP	28mm
BO-025SBP	66mm
BO-035SBP	84mm
BO-045SBP	92mm



**22 | O-SBP - SOLID RUBBER BUMPER PLATE**

- Bright colors
- Steel insert
- 15 lbs available
- Quality rubber

ITEM	WIDTH
O-010SBP	25.5mm
O-025SBP	51mm
O-035SBP	60mm
O-045SBP	79mm



**23 | GBO-SBP - USA SOLID RUBBER BUMPER PLATE**

- 15 lbs available
- Steel insert
- Non-greasy

ITEM	WIDTH
GBO-010SBP	24mm
GBO-015SBP	30mm
GBO-025SBP	46mm
GBO-035SBP	60mm
GBO-045SBP	79mm



**24 | AOB-1500C/AOB-1200C - MEN & WOMEN'S CERAKOTE BAR**

**TROY**<sup>®</sup>  
BARBELL & FITNESS

The Troy Fitness Cerakote Olympic Bar delivers great performance and durability you can depend on. Bronze bushings, which provide a friction less spin, reduce wear and tear. The Cerakote coating prevents rust and maximizes the life of this bar. The custom color options also allow schools to show their pride with a variety of chip-free color options. These Olympic bars are designed and built for any Athletic or Commercial Facility.



**25 | GO-U - INTERLOCKING URETHANE GRIP PLATES**

Our Troy premium grade, “Quiet Iron® EZ-lift” grip plates set the standard for excellence with their unique design, exceptional quality and durability – so much so in fact, that we give them a 5 year warranty.

- 2% plus or minus of actual weight
- Tri-hole

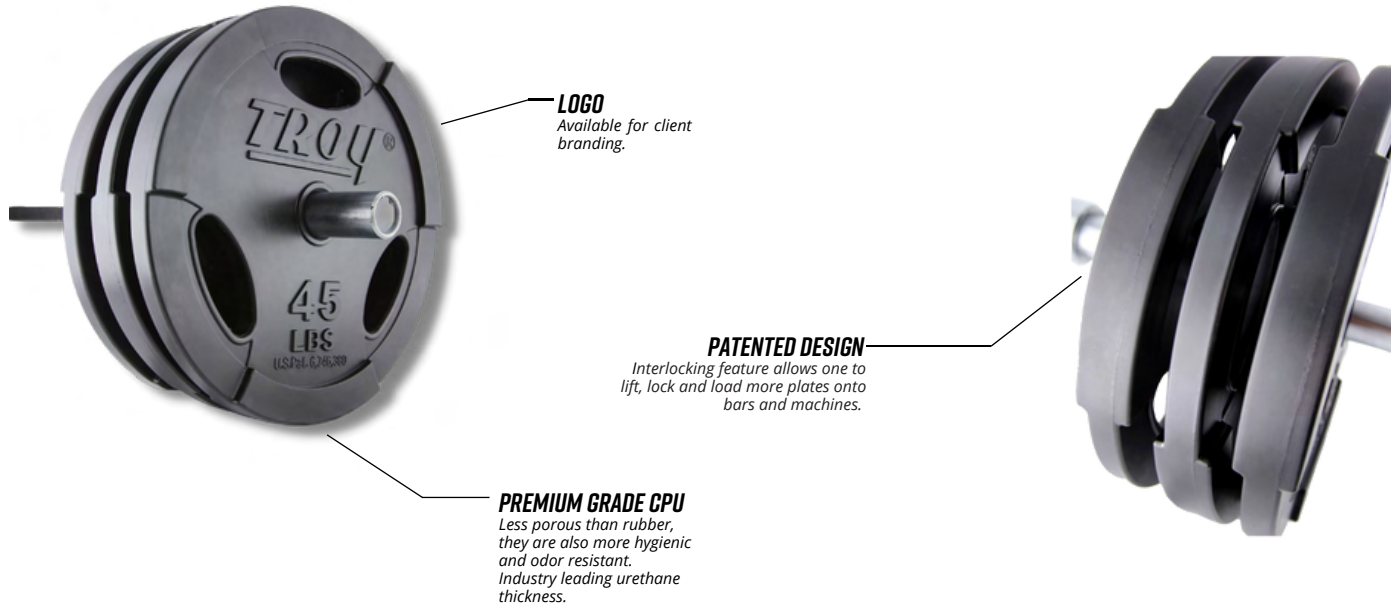

**26 | GO-R - INTERLOCKING RUBBER GRIP PLATES**

Our Troy premium grade, “Quiet Iron® EZ-lift” grip plates set the standard for excellence with their unique design, exceptional quality and durability – so much so in fact, that we give them a 5 year warranty.

- 2% plus or minus of actual weight
- Tri-hole





**27 | GO - TROY MACHINED GRIP PLATE**

Our high-grade Machined Interlocking Grip Plate is made out of highest quality ASTM Grade 20 cast iron and is designed to be used in the heaviest situations. The interlocking feature allows the user to safely load more plates onto machines and bars to maximize workouts. This unique feature makes TROY plates easier to lift and load. Our Olympic GO plates are designed to maintain a 2% accuracy level, plus or minus.

- Premium grade ASTM cast iron
- Interlocking
- Hammertone gray finish
- 2% weight tolerance



**PATENTED DESIGN**  
*Interlocking feature allows one to lift, lock and load more plates onto bars and machines.*

**28 | GO-VU - VTX DUAL GRIP URETHANE PLATE**

The new VTX urethane dual grip plate is the perfect solution for any light institutional setting. Using high grade urethane and a unique look the GO-VU looks great out of the box, but even better with your logo on it

- High-grade urethane
- 2% weight tolerance
- Logo available for client branding



ITEM	WEIGHT
GO-002VU	2.5 lbs
GO-005VU	5 lbs
GO-010VU	10 lbs
GO-025VU	25 lbs
GO-035VU	35 lbs
GO-045VU	45 lbs

## 29 | GO-VR - VTX RUBBER GRIP PLATE

Affordable quality! Our VTX high grade, wide flanged, “quiet iron” rubber encased Olympic grip plates feature 3 slotted gripping areas (45lb, 35lb, 25lb and 10lb only) that actually raise them off of the ground, providing easier lifting and loading from a prone or angled position. The durable rubber coating protects the plates, floors and other equipment from damage.

- Tri-grip
- High-grade rubber encased
- 3% weight tolerance
- Grip slots on (10lbs - 45lbs)
- Steel inserts
- Raised reinforcements



ITEM	WEIGHT
GO-002VR	2.5 lbs
GO-005VR	5 lbs
GO-010VR	10 lbs
GO-025VR	25 lbs
GO-035VR	35 lbs
GO-045VR	45 lbs
O-100R	100 lbs

## 30 | GO-V - VTX GRIP PLATE

Affordable quality, our VTX high-grade, wide-flanged, Olympic Grip Plates feature 3 slotted gripping areas (45 lb., 35 lb., 25 lb. and 10 lb. only) that actually raise the plates off of the ground, providing easier lifting and loading from a prone or angled position. Raised reinforcements on both sides of each grip slot help make it a true institutional plate and the choice of trainers, world wide. Center bores are precision drilled for a snugger fit on most 2” Olympic bars. Rust resistant, twice baked gray enamel finish.

- ASTM grade 20 cast iron
- 3% weight tolerance
- Grip slots on (10lbs - 45lbs)
- Raised reinforcements
- Quality baked enamel finish



ITEM	WEIGHT
GO-002V	2.5 lbs
GO-005V	5 lbs
GO-010V	10 lbs
GO-025V	25 lbs
GO-035V	35 lbs
GO-045V	45 lbs

**BARS**

**31 | AOB-2000T - TROY POWER BAR**

Make: USA  
 Yeild: 202,800 P.S.I.  
 Shaft/Sleeve Finish: Bright Zinc  
 Sleeve Attached: Snap Rings  
 Bushings: Self-Lubricating Bronze  
 Center Knurling/ Type: Yes/Aggressive  
 Shaft Diameter: 28.5mm  
 Weight: 45lbs (20.4 kilos)



**32 | TOZ-47 - TROY OLYMPIC CURL BAR**

Make: International  
 Weight Capacity: 150lbs  
 Shaft/Sleeve Finish: Chrome or Black Painted  
 Sleeve Attached: Double Roll Pins  
 Bushings: Steel  
 Center Knurling/ Type: No/ Medium  
 Shaft Diameter: 27mm  
 Weight: 18lbs



**33 | TOZ-60B - DELUXE 5' TROY CURL BAR**

Make: International  
 Weight Capacity: 250lbs  
 Shaft/Sleeve Finish: Black Oxide  
 Sleeve Attached: Bolted  
 Bushings: Bronze  
 Center Knurling/ Type: Yes/ Medium  
 Shaft Diameter: 30mm  
 Weight: 26lbs



**34 | GOB-1800/GOB-800 - VTX TRAINING BAR**

**MENS- GOB-1800**  
 Make: International  
 Yeild: 270,000 P.S.I.  
 Shaft/Sleeve Finish: Oxide (Patina)  
 Sleeve Attached: Dual Snap Rings  
 Bushings: Bronze  
 Center Knurling/ Type: No/ Light  
 Shaft Diameter: 28.5mm  
 Weight: 44lbs (20 kilos)  
 Length: 7ft

**WOMENS- GOB-800**  
 Make: International  
 Yeild: 164,600 P.S.I.  
 Shaft/Sleeve Finish: Oxide (Patina)  
 Sleeve Attached: Dual Snap Rings  
 Bushings: Bronze  
 Center Knurling/ Type: No/ Light  
 Shaft Diameter: 25mm  
 Weight: 33lbs (15 kilos)  
 Length: 6.5ft



### **35** | ***GOB-1200 - 7FT INTERNATIONAL POWER BAR***

Make: International  
Yield: 140,000 P.S.I.  
Shaft/Sleeve Finish: Hard Chrome  
Sleeve Attached: Dual Snap Rings  
Bushings: Bronze  
Center Knurling/ Type: No/ Light  
Shaft Diameter: 32mm  
Weight: 44lbs (20 kilos)



### **36** | ***AOT-56 - HEX BAR***

Make: International  
Shaft/Sleeve Finish: Hard Chrome  
Sleeve Attached: Fixed Solid Steel  
Weight Capacity: 600lbs  
Handles: Lightly Knurled  
Shaft Diameter: 25.4mm  
Weight: 50lbs



### **37** | ***SBCB-47 - SUPRABAR CURL BAR***

Make: International  
Sleeve Attached: Solid Bar Design  
Knurl: Light  
Weight: 25.2lbs  
Length: 47in



**RACKS & BENCHES**



**38 G-PR - APOLLO POWER RACK**

The Troy Fitness Apollo Power Rack is our base power rack system designed with safety and modularity in mind for athletic and commercial facilities. Each column features uniform holes on every side to allow for multiple configurations and attachment setups. The adjustable height safety bars provide versatility in use, whether that is squats, presses, or bodyweight exercises. Featuring 3x3" 11-gauge steel with oversize 1" diameter hardware, this rack is built to stand alone or bolted onto flooring.

## FEATURES



**J-HOOKS**



**SAFETY ARMS**



**WEIGHT HORNS**



**LOGO ARCH**



**SINGLE BAR HOLDER**



**BAND PEGS**



**HANGING BAR HOLDER**

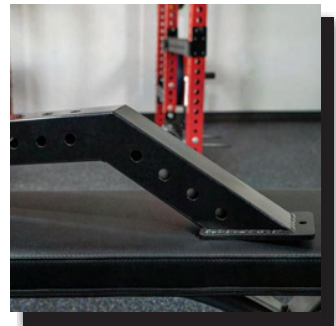

**FOOT EXTENDER**



**MULTIGRIP PULL BAR**

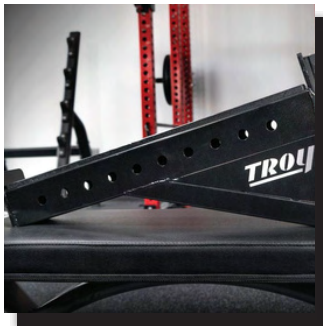

**SPOTTER ARMS**



**STRAP SAFETIES**



### 39 | G-HR - APOLLO HALF RACK

The Troy Apollo Half Rack is a versatile performance strength training area that packs a lot into a small space. The rack features 3"x 3" uprights with 11-gauge steel and a base foot print of 49W X 51D. Comes equip to take on any workout you can throw at it with plenty of storage space. Combined with other racks and accessories to fit a workout area for any athlete.

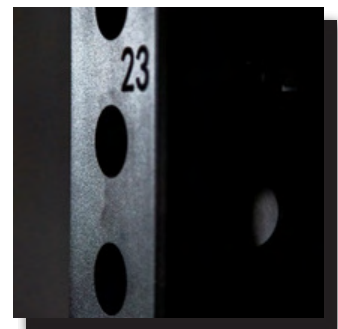
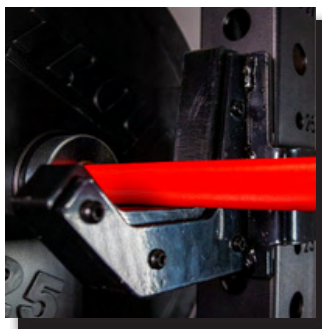

40 | **G-AB-L - TROY LADDER BENCH**

# Troy Barbell Ladder Bench

A powerhouse of strength and style for your fitness space

## Key Features

- 1000lb Rating: Unmatched durability for intense workouts.
- Versatile Design: Adapt to various exercises with the ladder-style construction.
- Durable Build: Precision engineering for longevity and comfort.
- Stylish Matte Finish: Choose from Black, Red, or White frames to suit your aesthetic.
- Space-Saving: Compact design ideal for home and commercial gyms.
- Easy Maintenance: Robust materials for hassle-free cleaning.



**G-AB-L-RED**

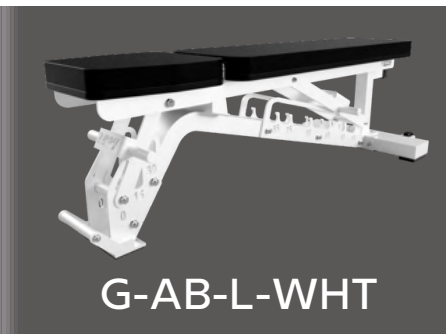

**G-AB-L-WHT**



**G-AB-L-BLK**

Elevate your fitness with the Troy Barbell Ladder Bench – where strength meets sophistication. Choose your color, embrace the power, and redefine your workout routine.



**41 | GTBH-FID - TROY ADJUSTABLE WEIGHT BENCH**

Unlock Your Full Fitness Potential with the Troy Adjustable Weight Bench - A Game-Changer for Commercial Gyms and Athletic Facilities! This rugged and versatile FID bench offers multiple incline and decline settings, adjustable seat positions, high-density foam padding for a comfortable workout experience, and convenient built-in wheels for easy mobility. With a robust 1000 lb weight capacity, it's ready for the toughest weightlifting routines. Explore the ultimate adjustable weight bench for your fitness goals today.



**42 | G-FB - FLAT BENCH**

The Troy Fitness Commercial Flat Bench features premium styling combined with comfort for enjoyable daily use. With its comfortable pad, rubber feet and end caps to protect floors, this bench extends the comfort to your facility space. The built-in wheels allow you to quickly maneuver the bench to speed along workouts. Use the band hooks along the feet to add an extra challenge to your workouts.



**43 | GVBH-FID - VTX FLAT/INCLINE/DECLINE BENCH**

Our rugged and versatile VTX FID bench is the ideal choice for any light commercial facility or personal gym. It features an 8-position, back rest adjustment, high-density foam padding for a firm, comfortable workout, wheels for easy transport and a unique 4 hook system for tension band utilization, to enhance your workout regimen. Simple 2 piece assembly.



# KETTLEBELL & STORAGE



## 44 | KB-G2 - VTX CAST IRON KETTLEBELL

Intended to increase strength, agility, endurance and balance, our new black cast iron kettlebells will give you a total body workout. With new dual markings for both lb and KG the new VTX Matte Black kettlebell will be a favorite for everyone.



## **45 | KBR-14 - KETTLEBELL RACK**

Our 2 tier kettle bell rack is a stylish and sensible way to display and store your bells. Supported by a 12 gauge frame, each heavy duty shelf has a 400lb weight capacity, making this rack capable of handling 14 individual sizes or 7 pair (20lbs thru 50lbs) of kettle bells.



## **46 | VKB - VINYL KETTLEBELLS**

Intended to increase strength, agility, endurance and balance, our colorful vinyl kettlebells will give you a total body workout.



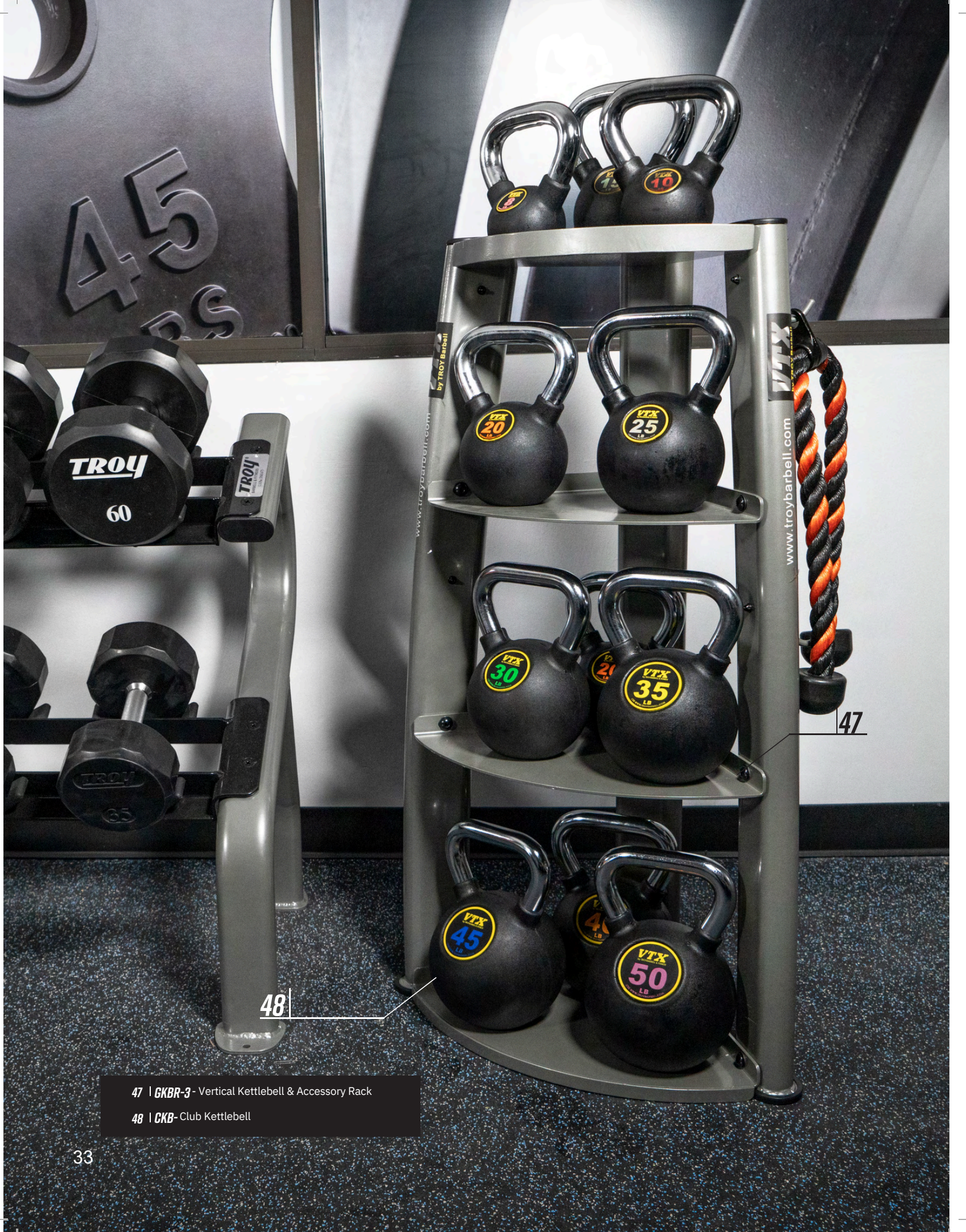

by TROY Barbell  
www.troybarbell.com

VTX  
www.troybarbell.com

47

48

47 | GKBR-3 - Vertical Kettlebell & Accessory Rack  
48 | GKB - Club Kettlebell

## **47 | GKBR-3 - VERTICAL KETTLEBELL & ACCESSORY RACK**

Our VTX GKBR-3 is a stylish, space saving, small footprint rack that conveniently stores multiple Kettlebells, bands, jump ropes and other accessory pieces. With its 4 shelves, 4 hooks and corner design, the VTX GKBR-3 is the perfect solution for facilities or homes with limited space.



## **48 | CKB - CLUB KETTLEBELLS**

Rubber coated bell, smooth steel handles, colorful and easy to read poundage markers make the new CKB from VTX the best kettlebell for any gym, box, PT studio or any facility that wants a combination of exceptional quality and stylish design.





### 49| **GVFB - FLAT BANDS**

The VTX Flat Bands Kit consists of 3 flat bands and training manual. Durable, latex-free bands for versatile and effective resistance training to tone and shape your entire body. Perfect for rehab; ideal for pre-game or pre-activity warm up, and stretching.



### 50| **G-VYB - YOGA BLOCK**

The VTX Yoga Block is a sturdy yet lightweight block made of smooth-grip foam and is ready to handle the most rigorous workouts. Extend your reach and get the most from your yoga workout with the VTX Yoga Block.



## 51 VD - VINYL DUMBBELL

Intended to increase strength, agility, endurance and balance, our colorful vinyl kettlebells will give you a total body workout.



## 52 G-VYM-BLK - YOGA MAT

The VTX Yoga Mat is double cushioned closed cell foam with a non-slip surface providing extra comfort and protection for yoga poses, pilates exercises, HIIT yoga fusion and, stretching routines. The Yoga Mat easily rolls up for storage and wipes clean with a damp towel, making every session doubly effective and efficient.



## 53 GVFB-L - LOOP BANDS

The VTX Mini Loop Bands are travel size to elevate your workout at home or on the go. These mini bands bring impressively strong resistance to improve your muscle stability in multiple muscle groups. Resistance includes 5lbs (yellow), 10lbs (orange), 15lbs (blue), 20lbs (black).



## 54 GVFB-ML - MINI LOOP BANDS

The VTX Loop Bands are an excellent way to strengthen and tone your lower body. The size of this exercise tool makes it a great "Go Anywhere, Train Anytime" tool. The band resistances are approximately equal to 5lbs (yellow), 10lbs (orange), 20lbs (blue), 25lbs (black).



# VTX



## **55 | G-VFR - FOAM ROLLER**

The VTX Foam Roller is designed for deep tissue massages withstanding heavy use. This aggressive, deep-tissue massage therapy improves alignment and hip mobility while supporting muscle recovery and regeneration. Alleviate sore muscles and fatigue as often as you need.



## **56 | GVSBL - STRENGTH BANDS**

The VTX Strength Band's continuous latexloop offers variable weight resistance with each band. Four Strength Band's are available, light, medium, heavy, and extra heavy, each with a gradually greater weight range. You get virtually hundreds of resistance-exercise options. 20lbs-35lbs, 30lbs-50lbs, 40lbs-80lbs, and 60lbs-120lbs of resistance.





## 57 | ROPE1-40G - VTX TRAINING ROPE

VTX Training Ropes provide an intense, full body workout. Each rope is constructed of fray resistant, polyethylene and sports durable rubber hand grips on each end to guard against rope burn. There are 2 different thicknesses (1.5" & 2") and lengths (40' & 50') to choose from. Utilize the VTX training rope in your workout regimen as a fun and innovative way to burn fat, develop endurance and build lean muscle.



57 |

# WARRANTIES

## ***USA SPORTS WARRANTY***

All USA Sports, Inc products come with a 90-day warranty against breakage through proper use to the original owner and do not cover normal wear and tear. This warranty does not cover products placed in a commercial setting. USA Sports, Inc guarantees all products on shipment date to be free of material defects or workmanship faults. EXCEPT FOR THE EXPRESSED WARRANTIES PROVIDED HEREIN, ANY AND ALL OTHER WARRANTIES, INCLUDING THE IMPLIED WARRANTIES OF MERCHANTABILITY AND FITNESS FOR A PARTICULAR PURPOSE ARE HEREBY DISCLAIMED.

## ***VTX® WARRANTY***

VTX products come with a full 1-year warranty against manufacturer defects or breakage through improper use by the end-user in light commercial setting. This 1-year warranty does cover in a light commercial setting. Rubber products may carry a slight odor. This odor should be considered normal and will not be covered under warranty.

## ***TROY® WARRANTY***

TROY guarantees all products from the date of shipment to be free of materials defects. The warranty extends to the original consignee or end-user only. The warranty only covers failures due to material defects or workmanship that occurs during regular use. It does not cover product failures due to misuse, negligence, misapplication, modification, or normal wear and tear. The warranty detail is as follows.

***PRODUCT***

***WARRANTY DETAILS***

American Bars	Limited 5 year warranty against manufacturer defects or breakage. This warranty does not cover rust, bending due to misuse, or any defect caused from use outside the functional capacity of the bar in question.
Cast-Iron Plates	Limited 10-year warranty against breakage and 1 year warranty against manufacture defects. This warranty does not cover paint chipping or rusting.
Rubber Encased Plates	Limited 10-year warranty against breakage and 1-year warranty against manufacture defects. This warranty does not cover rubber loss due to chipping, fading, or cracking.
Urethane Encased Plates	Limited 10-year warranty against breakage and 5-year warranty against manufacturer defects.
Cast & Rubber Pro-Style Dumbbells and Barbells	Limited 10-year warranty against breakage and 1-year warranty against manufacture defects. This warranty does not cover bent handles, paint chipping, rusting or improper use including dropping or slamming the product.
Urethane and Rubber Encased Solid Dumbbells	Limited 5-year warranty against breakage and manufacture defects. This warranty does not cover the loss of rubber due to chipping, fading, cracking or improper use including dropping or slamming the product.
Commercial Series Racks	Limited Lifetime warranty against breakage and 1-year warranty against manufacture defects.
All Other Troy products	All other Troy products will carry a 1-year warranty against breakage and manufacture defects.



**TROY**

**40**



**TROY**<sup>®</sup>  
**BARBELL & FITNESS**

**VTX**

**USA** 

*FOR ADDITIONAL INFORMATION:*

*PHONE: 800-872-7767*

*WEBSITE: [WWW.TROYFITNESS.COM](http://WWW.TROYFITNESS.COM)*

*CORPORATE OFFICE*

*10600 SHADOW WOOD DR. STE 301*

*HOUSTON, TX 77043*